

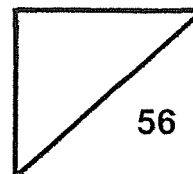

Rosyth School
End-of-Year Examination 2021
SCIENCE
Primary 5

Name: _____

Total
Marks:



Class: Pr 5- _____

Register No. _____

Total time for
Booklets A and B: 1 h 45 min

Date: 27 October 2021

Booklet A

Instructions to Pupils:

1. Do not open the booklet until you are told to do so.
2. Follow all instructions carefully.
3. This paper consists of 2 booklets, Booklet A and Booklet B.
4. For questions 1 to 28 in Booklet A, shade the correct ovals on the Optical Answer Sheet (OAS) provided using a 2B pencil.

* This booklet consists of **19** printed pages (including cover page).

For each question from 1 to 28, four options are given. One of them is the correct answer. Make your choice (1, 2, 3 or 4). **Shade the correct oval (1, 2, 3 or 4) on the Optical Answer Sheet.** (56 Marks)

- 1 The following table gives information on four plants, A, B, C and D, based on two characteristics.

Characteristics	Plant			
	A	B	C	D
It bears fruit.	No	Yes	No	Yes
It grows on land.	Yes	No	No	Yes

From the information in the table above, the plants are classified in the classification chart below.

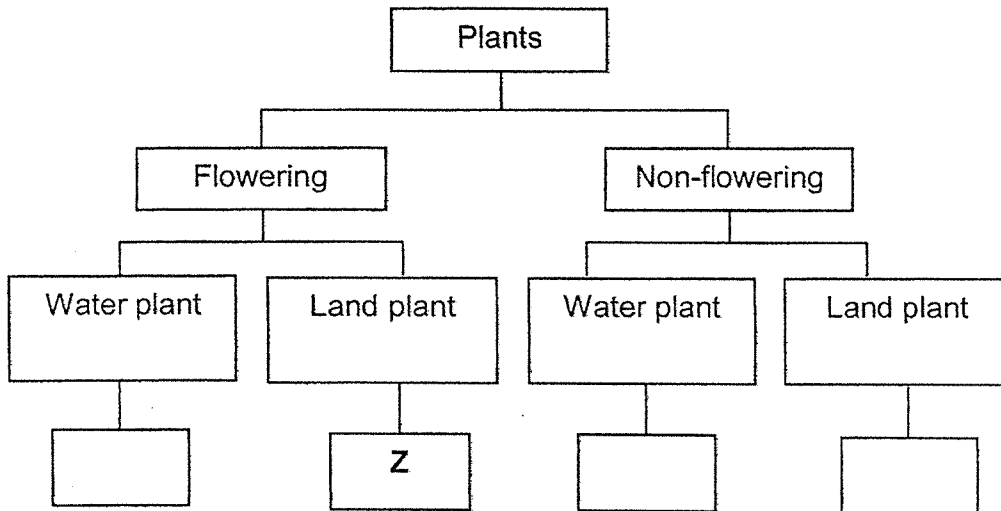

Which plant can be classified under Z?

- (1) A
- (2) B
- (3) C
- (4) D

2 The diagram below shows the four stages in the life cycle of an organism.

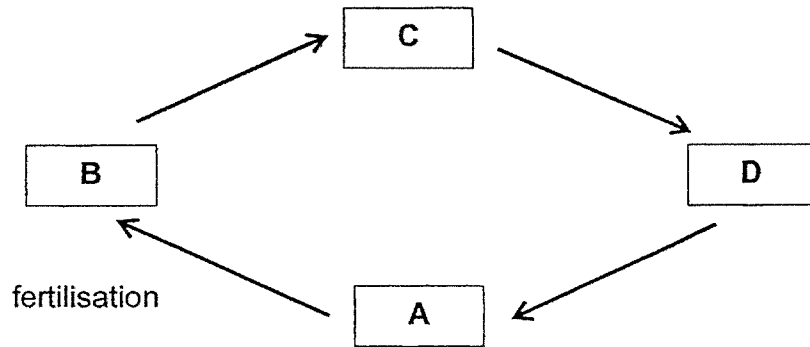

Identify the correct stages, A and D, in the above life cycle.

	A	D
(1)	egg	adult
(2)	egg	pupa
(3)	adult	larva
(4)	adult	pupa

3 X, Y and Z are parts in the human digestive system.

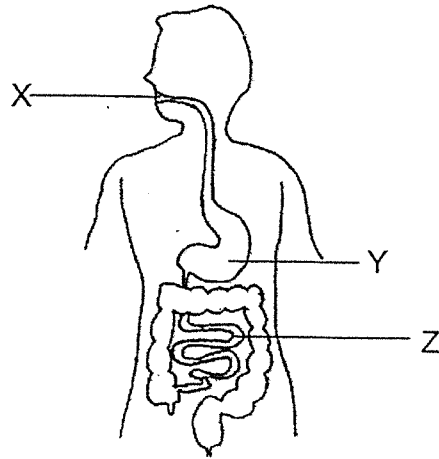

The graphs below show the amount of digested and undigested food reaching each organ after a meal.

Which one of the following graphs correctly shows the amount of digested and undigested food in Parts X, Y and Z?

Key: represents undigested food
 represents digested food

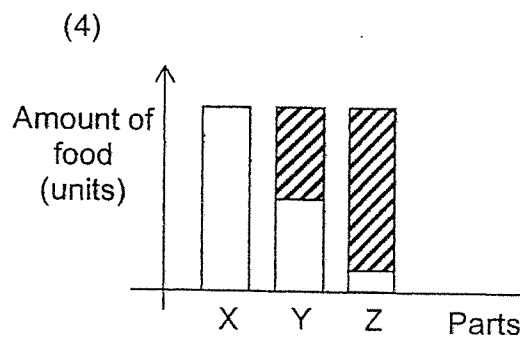
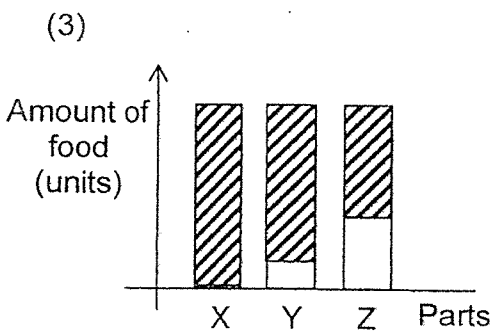
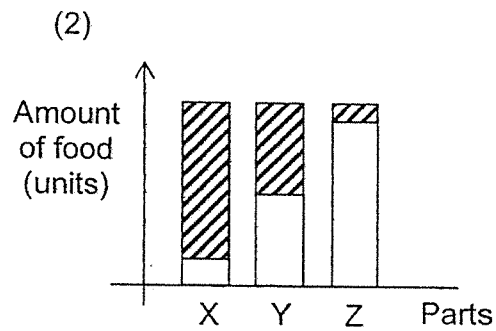
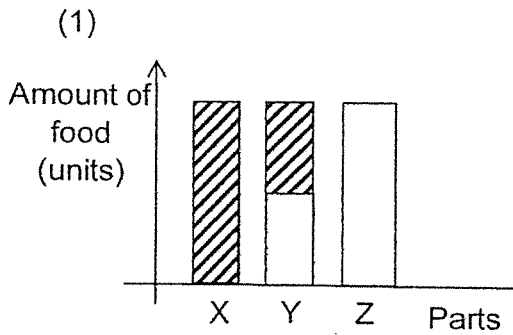

4 Which of the following shows the basic unit of life in a human and a plant?

	Human	Plant
(1)	nucleus	nucleus
(2)	cell membrane	cell
(3)	cell	cell
(4)	nucleus	chloroplast

5 The table below provides some information on four cells, A, B, C and D. A tick (✓) indicates the presence of the cell part.

Parts of a Cell	Cell A	Cell B	Cell C	Cell D
cell membrane	✓	✓	✓	✓
nucleus	✓	✓	✓	✓
cell wall	✓	✓		
chloroplast		✓		✓

The picture below shows a banana tree with unripe banana. Unripe bananas are green in colour.

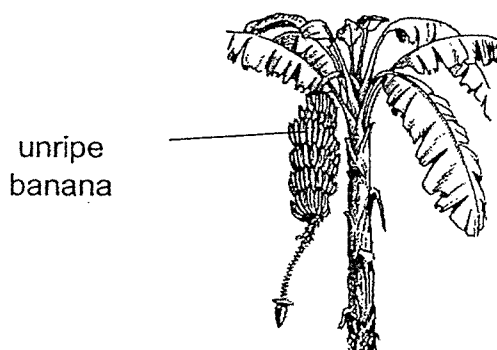

Which cell would represent the skin of the unripe banana correctly?

- (1) Cell A
- (2) Cell B
- (3) Cell C
- (4) Cell D

6 The table below shows some characteristics of apples, A and B.

Characteristics	Apple A	Apple B
Size	big	small
Taste	juicy	sweet
Days to ripen	10	12

A scientist wanted to create a type of apple that is big, sweet and juicy and will ripen very quickly. He took part of a cell from apple A and apple B respectively.

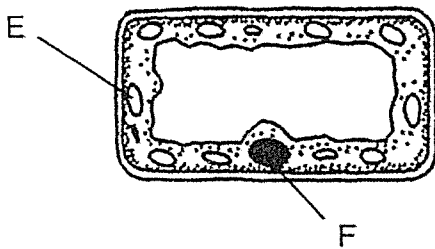

cell from apple A

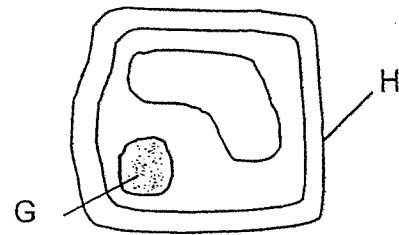

cell from apple B

Which one of the following cell parts should the scientist modify so that he can create the apple that he wants?

- (1) E and G
 - (2) E and H
 - (3) F and G
 - (4) F and H
- 7 Which parts of a plant need oxygen?
- (1) all parts of a plant
 - (2) leaves and roots only
 - (3) none of the parts of a plant
 - (4) leaves, roots and stem only

- 8 Geran wanted to have two set-ups, M and N, for her experiment. Set-up M is as shown below.

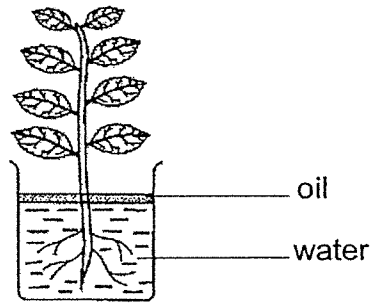

set-up M

Her hypothesis is: The greater the amount of roots, the greater the amount of water absorbed by the plant.

Which one of the following set-ups should she use as set-up N for her experiment?

(1)

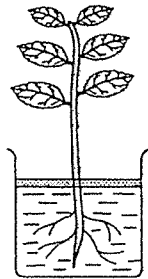

(2)

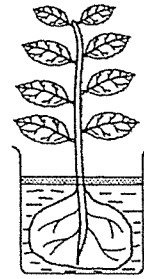

(3)

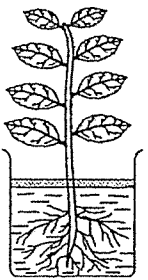

(4)

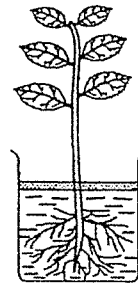

- 9 Peter drew the diagram below to show how substances are transported to and from the different parts of the plant represented by P, Q and R.

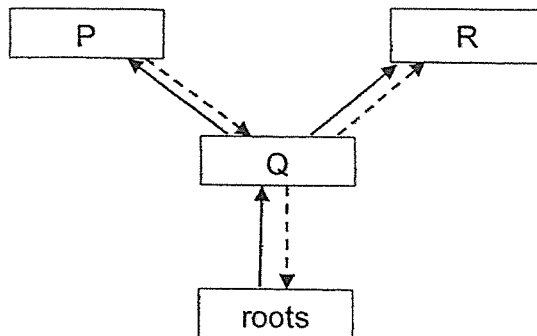

Which one of the following correctly represents the arrows?

	—————→	-----→
(1)	water	mineral salts
(2)	mineral salts	water
(3)	water	food
(4)	food	food

- 10 A group of people was trapped in a lift for 30 minutes as shown below.

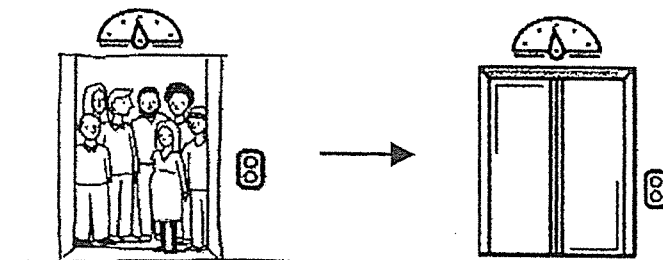

Which one of the following correctly represents the change in the amount of gases in the lift over the 30 minutes?

	Nitrogen	Carbon Dioxide	Oxygen
(1)	increased	decreased	increased
(2)	the same	increased	increased
(3)	the same	increased	decreased
(4)	decreased	increased	decreased

11 The diagrams below show the respiratory systems of a human and a fish.

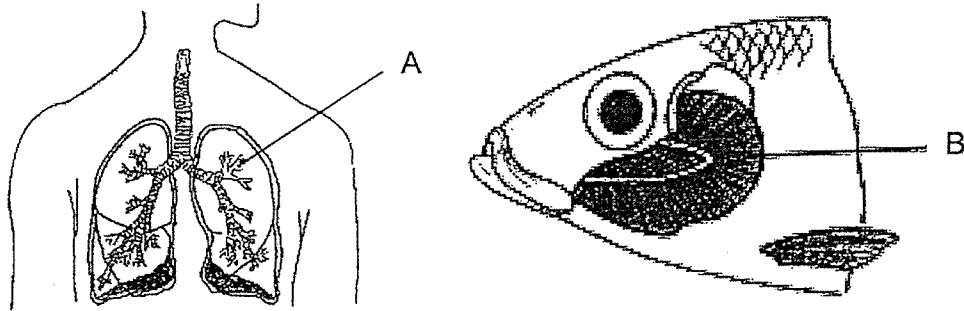

How are structures A and B similar?

- (1) They have air sacs.
- (2) They are rich in blood supply.
- (3) They take in oxygen from the air.
- (4) They take in nutrients and digested food.

12 The diagram below shows how the circulatory, respiratory and digestive systems in our body work together. The arrows represent the movement of blood in our body.

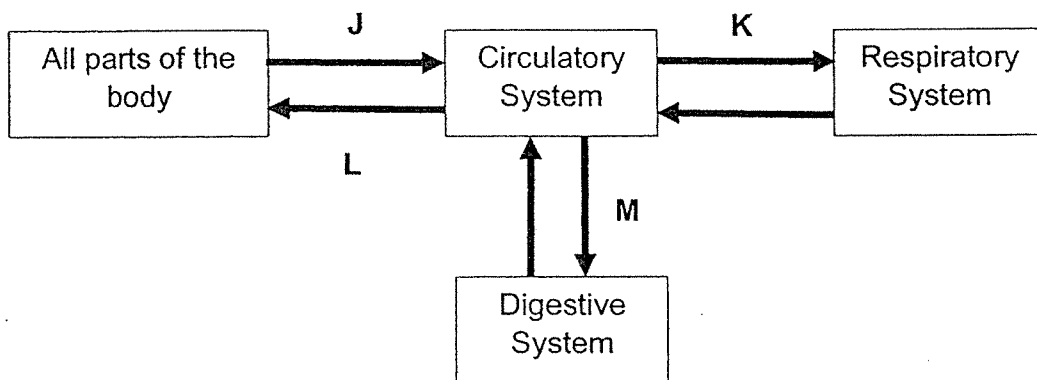

Which arrow, J, K, L or M, contains the most amount of carbon dioxide?

- (1) J
- (2) K
- (3) L
- (4) M

13 The diagrams below show the reproductive parts of a human and plant.

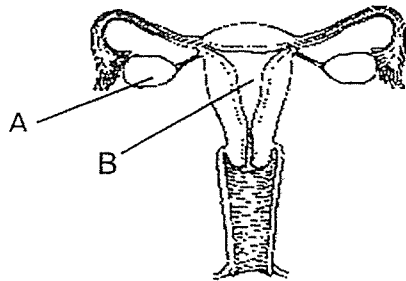

human reproductive system

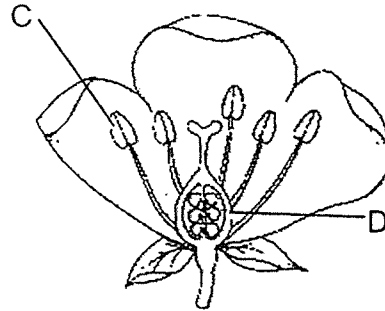

plant reproductive system

Which of the following statements is correct?

- (1) Fertilisation occurs in A and D.
- (2) The young develops in B and C.
- (3) A and D produce male reproductive cells.
- (4) Reproductive cells are produced in A and C.

14 A flowering plant undergoes processes at A and B as shown.

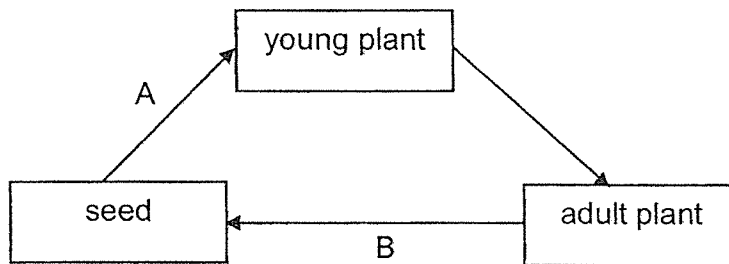

Which of the following is correct?

	Process(es) at A	Process(es) at B
(1)	seed dispersal only	pollination and fertilisation
(2)	pollination and fertilisation	seed dispersal only
(3)	seed dispersal and germination	fertilisation only
(4)	seed dispersal and germination	pollination and fertilisation

15 Which of the following objects is a poor conductor of heat?

- (1) a metal straw
- (2) a ceramic cup
- (3) an electromagnet
- (4) a piece of aluminium foil

16 Study the set-up below.

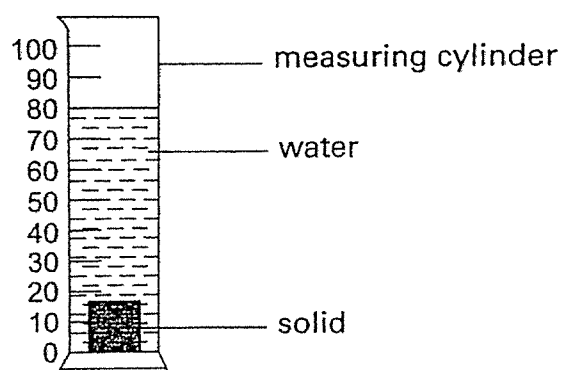

Based on your observation only, which of the following statements is correct?

- (1) The solid has mass.
- (2) The solid is lighter than water.
- (3) The volume of water is 80 cm^3 .
- (4) The volume of the solid is less than 80 cm^3 .

- 17 Two pieces of materials, A and B, of the same size and shape were placed in a tank of water. Both materials floated on water. After 30 minutes, material A remained afloat but material B sank to the bottom of the tank.

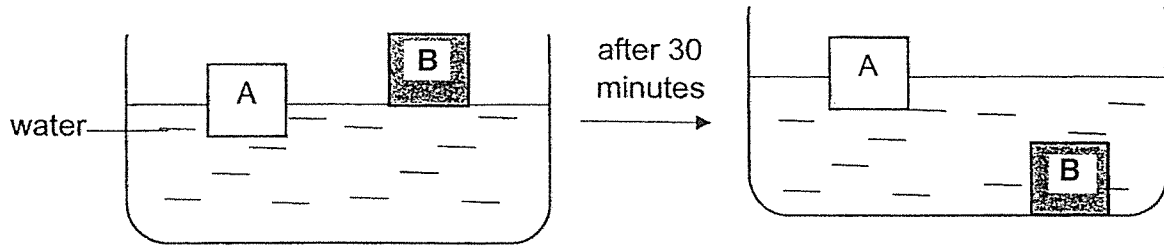

Which of the following is the best reason why material B sank after a while?

- (1) A and B have different mass.
 - (2) A absorbs more water than B.
 - (3) A is waterproof but B is not waterproof.
 - (4) A and B occupy different amount of space.
- 18 Which of the following components are needed to make a simple circuit?
- (1) a bulb and a wire
 - (2) a bulb and a battery
 - (3) a bulb, a wire and a switch
 - (4) a bulb, a wire and a battery

- 19 The diagram below shows a set-up that uses identical lamps to heat food. Peter wants to find out if the arrangement of lamps in a circuit affects the amount of heat given out.

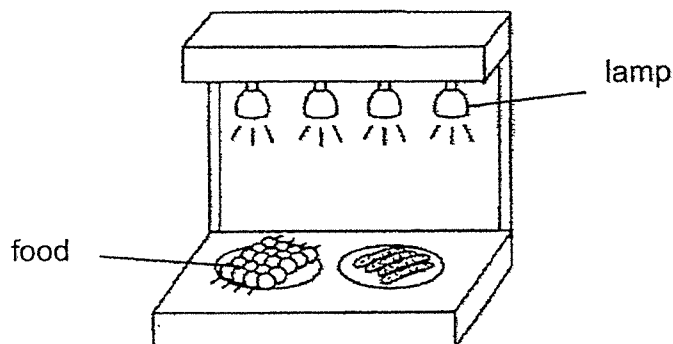

Which two set-ups should Peter use in his experiment?

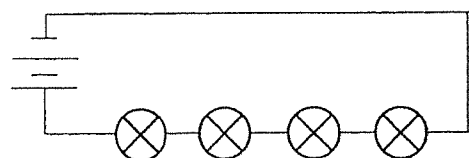

set-up A

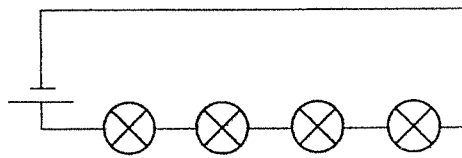

set-up B

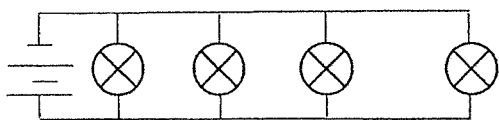

set-up C

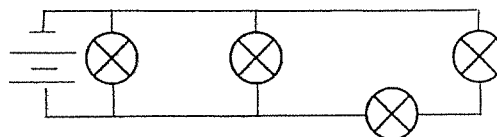

set-up D

- (1) A and B
- (2) A and C
- (3) B and C
- (4) B and D

- 20 Sanjiv set up a circuit tester with a battery, a bulb, two rods and some wires. He placed the circuit tester into liquid X in two set-ups as shown below.

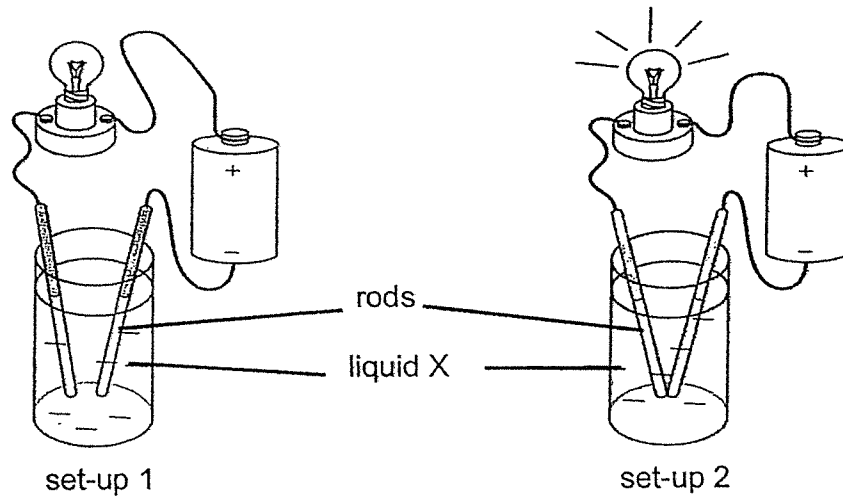

Which of the following statements explains why the bulb in set-up 1 did not light up but the bulb in set-up 2 did?

- (1) The rod is an electrical insulator.
- (2) Liquid X is an electrical insulator.
- (3) Liquid X is an electrical conductor.
- (4) The wires are electrical insulators.

21 Study the electric circuit as shown below.

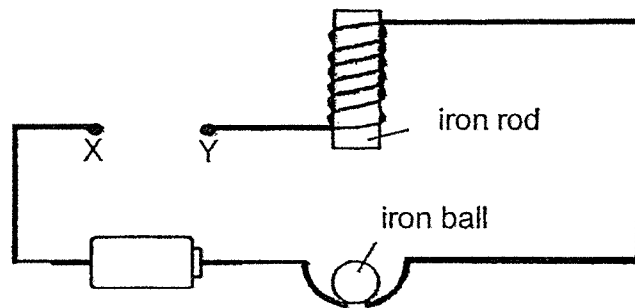

When X and Y are joined together, the iron ball is attracted to the iron rod and drops back into the holder repeatedly.

Which of the following, when placed between X and Y, would not cause the iron ball to be attracted by the iron rod?

- (1)
- (2)
- (3)
- (4)

22 The diagram below shows water that exists in three different states of matter.

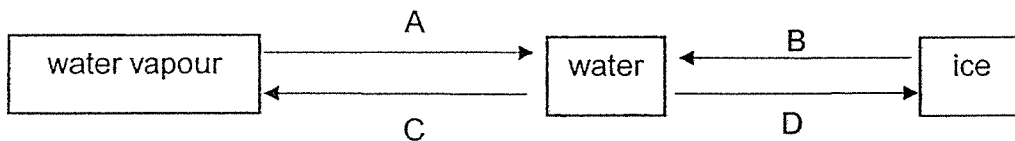

Which of the arrows in the diagram above represent a process that gains heat?

- (1) A and B
- (2) B and C
- (3) C and A
- (4) D and B

- 23 A block of ice was placed in an empty paper cup and left in a classroom. The room temperature was 30°C .

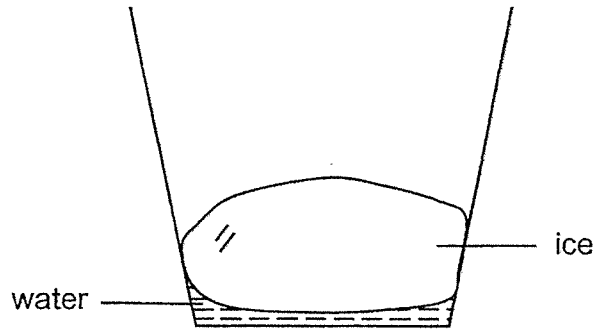

Which one of the following is true during the melting of ice?

- (1) The temperature of ice increases.
- (2) The temperature of ice decreases.
- (3) The temperature of the water below the ice is 0°C .
- (4) The temperature of the water around the ice is less than 0°C .

24 In which of the following scenario does water exist in one state only?

- (1) A kettle of boiling water
- (2) An ice cube in room temperature
- (3) A pot of water in room temperature
- (4) An ice cube in a freezer below 0°C.

25 An ice cube and some water were placed in a steel cup on a table. After some time, water droplets were seen on the outside of the cup.

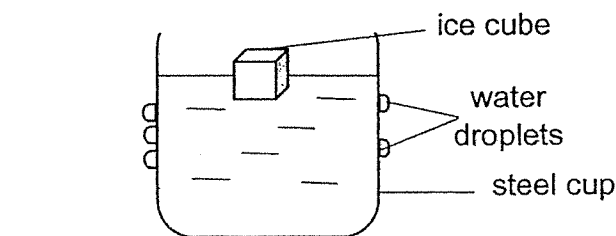

Which of the following processes are occurring?

- (1) freezing and evaporation only
 - (2) melting and condensation only
 - (3) melting, evaporation and condensation only
 - (4) freezing, evaporation and condensation only
- 26 The melting point and boiling point of substance X are shown on the scale below.

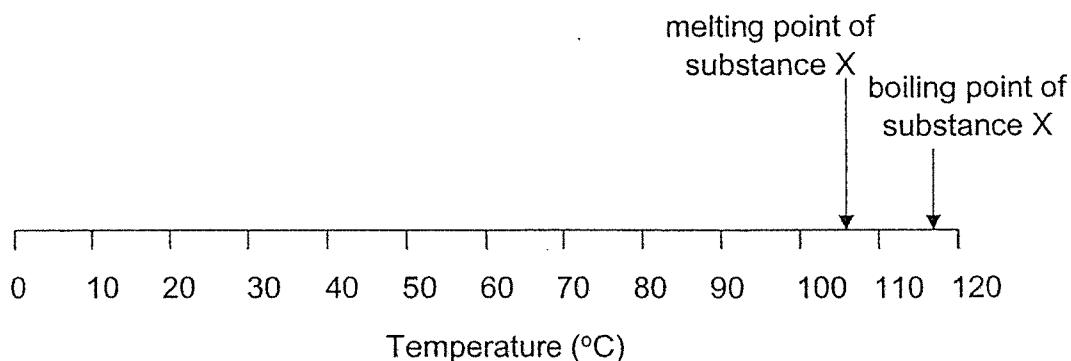

What will the state of substance X be when water is in a liquid state?

- (1) solid only
- (2) liquid only
- (3) mixture of solid and liquid
- (4) mixture of liquid and gas

- 27 Lily carried out an experiment to find out how different shapes of containers, A, B, C and D, will affect the rate of evaporation of water.

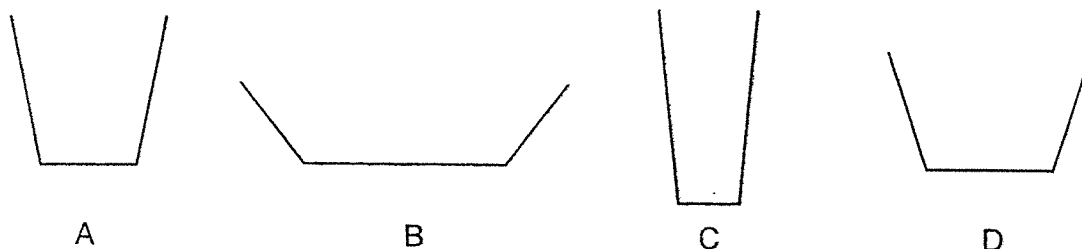

She added 100ml of water into each container and left the containers at the same place. After ten hours, she measured the amount of water left in each container as shown in the table below.

Container	Volume of water at the start of the experiment (ml)	Volume of water left after ten hours (ml)
A	100	70
B	100	90
C	100	80
D	100	50

Lily made an error in recording one of her results.

For which container did she record the results wrongly?

- (1) A
- (2) B
- (3) C
- (4) D

- 28 Rina was trying to dissolve a cube of sugar in a beaker of water as shown in the diagram below.

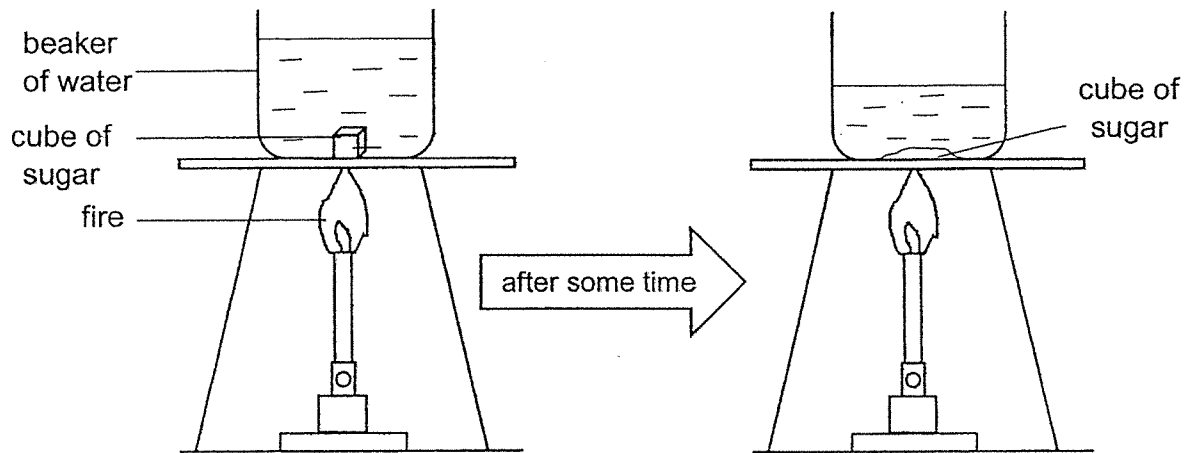

After some time, Rina noticed that the volume of water decreased.

What should Rina do to prevent the volume of water from decreasing?

- (1) Use more heat
- (2) Add in more sugar.
- (3) Use a bigger beaker.
- (4) Place a lid over the beaker.

Go to Booklet B



Rosyth School
End-of-Year Examination 2021
SCIENCE
Primary 5

Name: _____

Total
Marks:

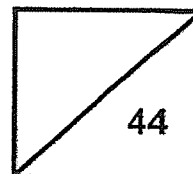

Class: Pr 5- _____

Register No. _____

Total time for
Booklets A and B: 1 h 45 min

Date: 27 October 2021

Parent's Signature: _____

Booklet B

Instructions to Pupils:

1. For questions 29 to 40, write your answers in the spaces given in this booklet.

	Maximum	Marks Obtained
Booklet A	56 marks	
Booklet B	44 marks	
Total	100 marks	

* This booklet consists of 15 printed pages (including cover page).

For questions 29 to 40, write your answers in the space provided. **(44 Marks)**

29 Study the flowchart below. Letters C to F represent different animals.

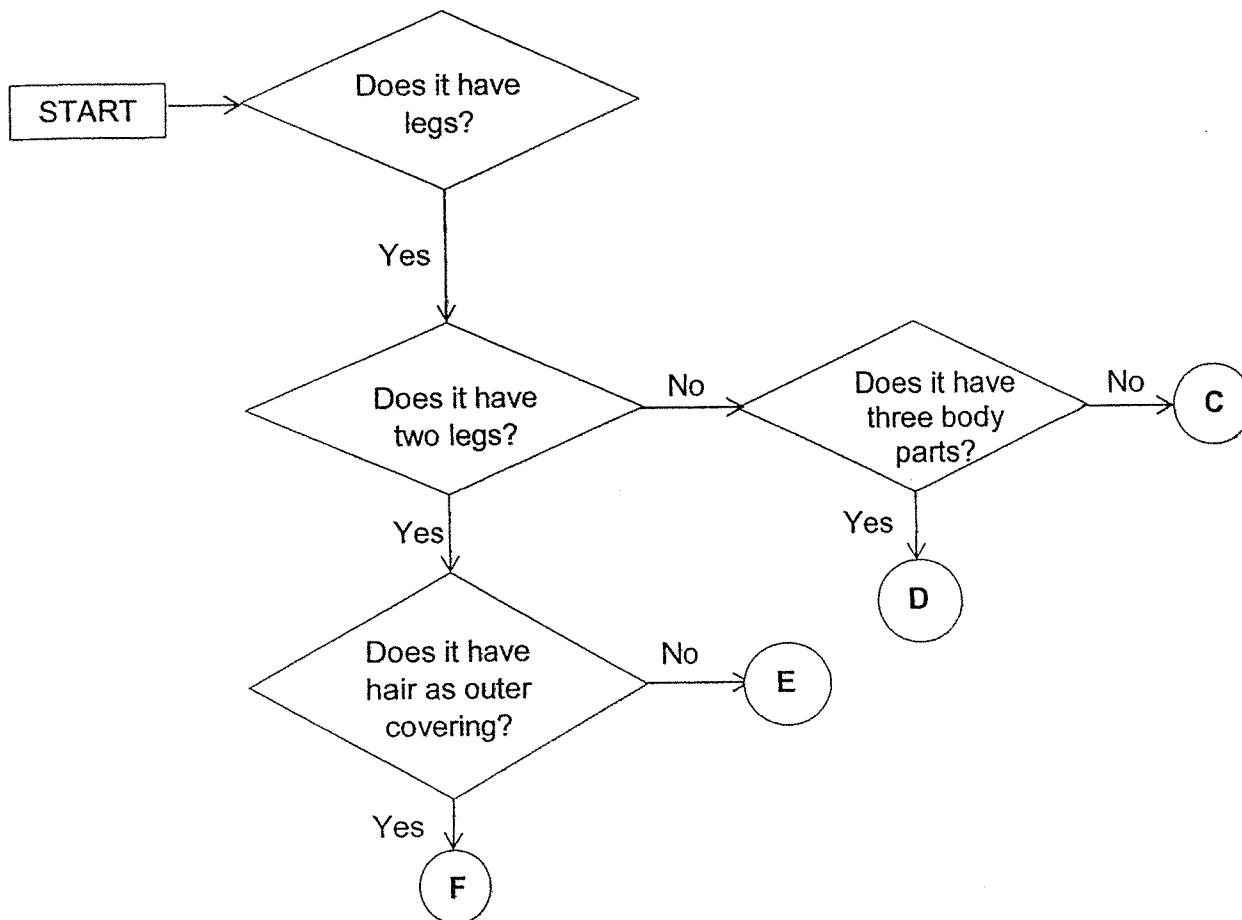

(a) Eric told his teacher that a grasshopper could be represented by animal D. Do you agree? Support your answer. [1]

(b) State one similarity between animals C and F. [1]

(c) Write down the letter (C, D, E or F) that best represent the Mammal group. [1]

(d) Is it possible for animal E to be a bird? Explain your answer. [1]

- 30 Jeffrey jogged for 30 minutes. His breathing rate and heart rate during the activity were measured and plotted into graphs as shown below.

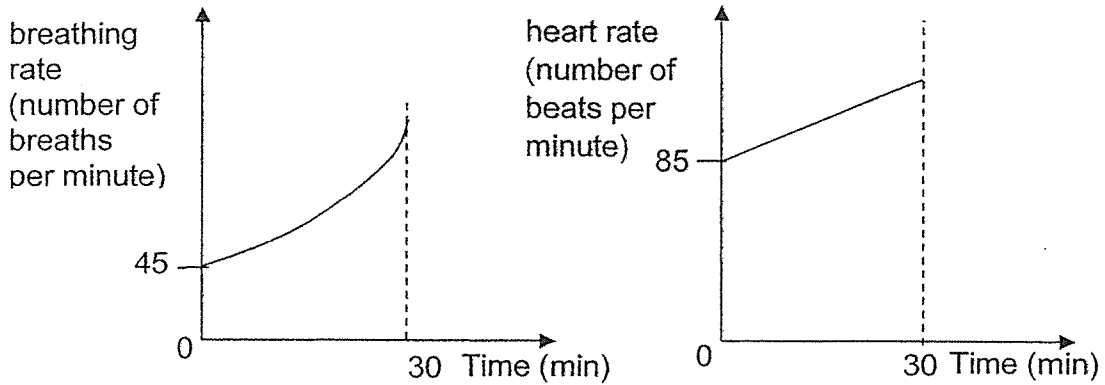

- (a) Identify the two body systems that resulted in the graph above. [1]

- (b) Based on the graphs shown above, how does the heart rate affect the breathing rate? [1]

- (c) Explain why Jeffrey's heart beats faster while jogging. [2]

31 The diagram shows a process that happens during human reproduction.

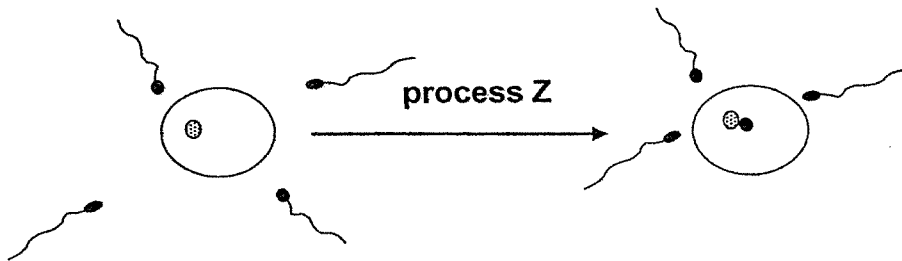

(a) Identify process Z. [1]

(b) Describe what happens during the process stated in (a). [1]

(c) Which part of the male reproductive system produces the sperms? [1]

- 32 In an experiment, four similar cells were placed separately into each set-up, A, B, C and D, containing different solutions. The observations were recorded in the table below.

Set-Up	Solutions	Observations
A	water	The cell swelled.
B	red solution (red dye and water)	The cell swelled and turned red.
C	blue solution (blue dye and water)	The cell swelled and no change in the colour of the cell.
D	mixture of red and blue solutions	?

- (a) What would the observations of the cell in set-up D be? [2]

- (b) Based on the table above, which part of the cell causes the above observations? Give a reason. [1]

33 The diagram below shows flower M with both male and female parts.

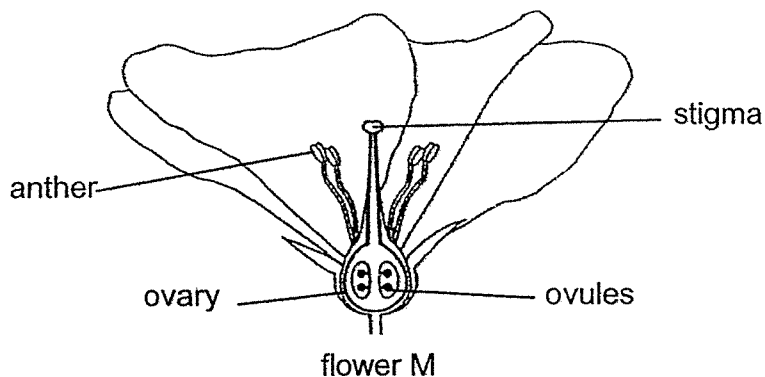

(a) If the anther was removed from flower M, would the flower still be able to undergo the process of fertilisation? Explain your answer. [1]

(b) Name the part of flower M that will develop into the seeds of the fruit. [1]

Study the picture of flower N of another plant.

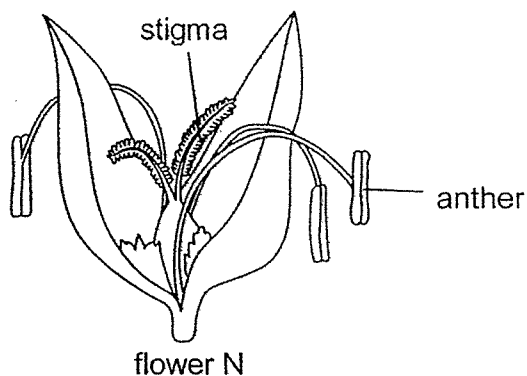

Flower N is dull in colour and has no smell.

(c) Explain how the characteristic of the male parts of flower N helps to enable pollination to take place. [2]

- 34 Jun Yu wanted to find out how temperature affects the number of days for roots to appear. He planted some seeds of the same plant, each at a different temperature. He counted the number of days it took for the roots to appear.

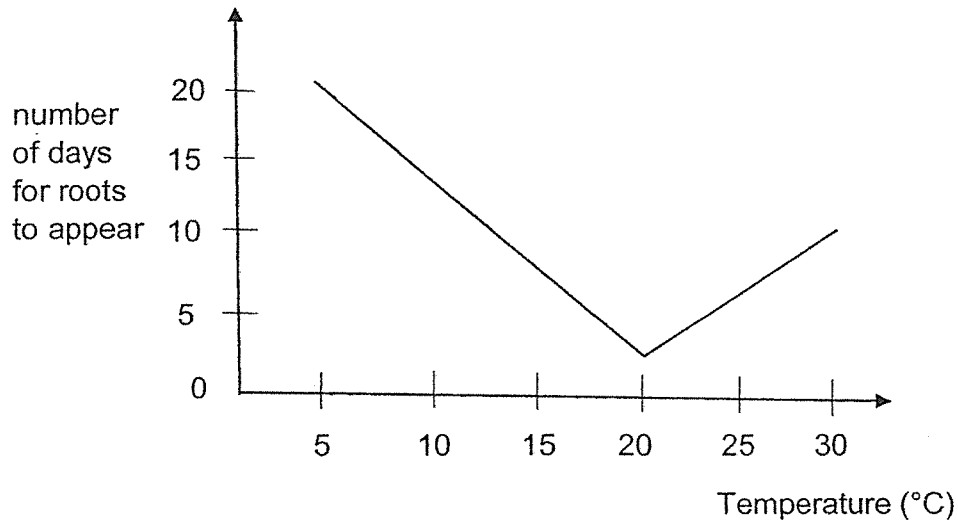

- (a) Based on the above results, explain how the changes in temperature affected the number of days taken for the roots to appear. [2]

- (b) State why it is important for the roots to appear first. [1]

- (c) Put a tick (✓) in the correct box below to show where the young plant get its food from. [1]

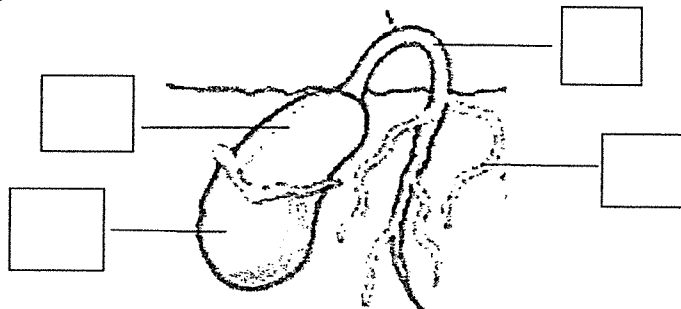

- 35 Elle placed a puppet on a table in a totally dark room. She did not switch on the torch in her hand.

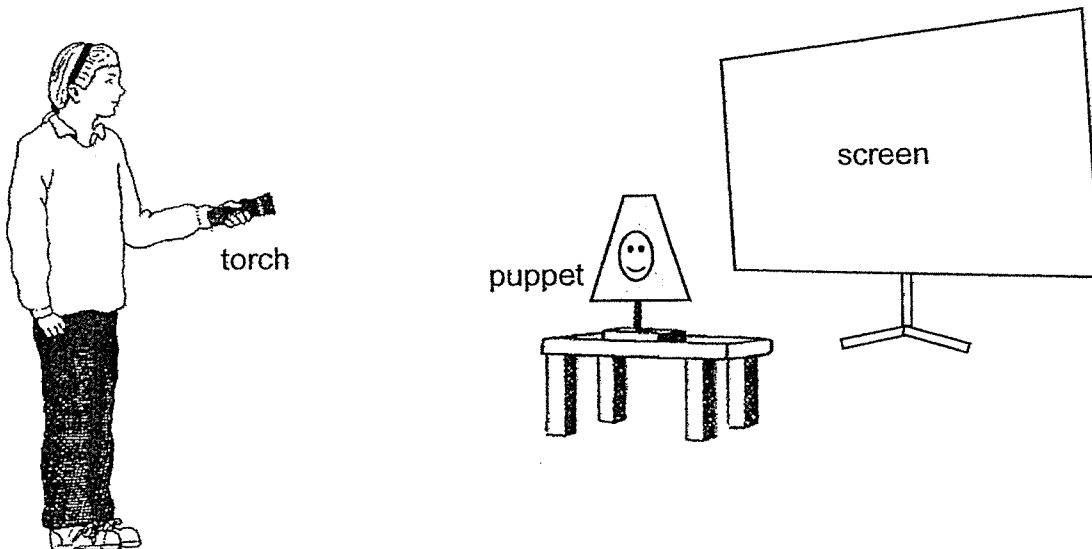

- (a) Elle was not able to see the puppet. Explain why. [1]

- (b) When Elle switched on the torch, a shadow was formed on the screen. Which of the following shows the correct shadow of Elle's puppet? Tick (✓) one box only. [1]

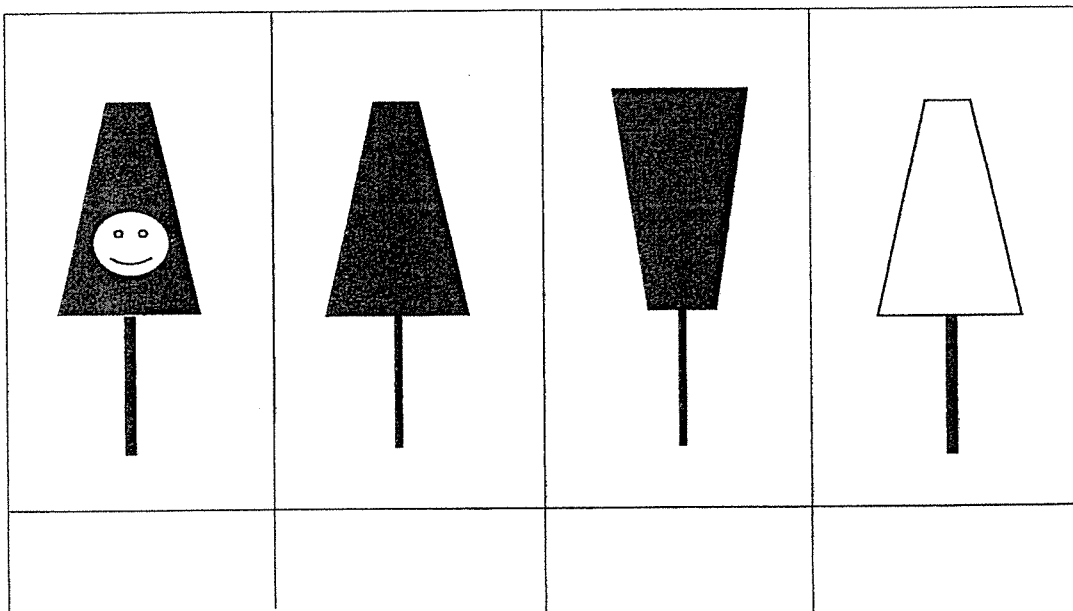

Question 35 continues on page 9

Elle conducted an experiment to find out how the distance of the puppet from the screen affected the height of the shadow formed on the screen.

Elle's results were recorded in the table below.

Distance of the puppet from the screen (cm)	Height of shadow on the screen (cm)
20	15
40	24
60	37
80	51

- (c) Elle wanted the height of the shadow to be 40cm. Predict the distance of the puppet from the screen. [1]

_____ cm

- (d) What can Elle conclude? [1]

36 Harry set up an experiment to observe the water cycle as shown below.

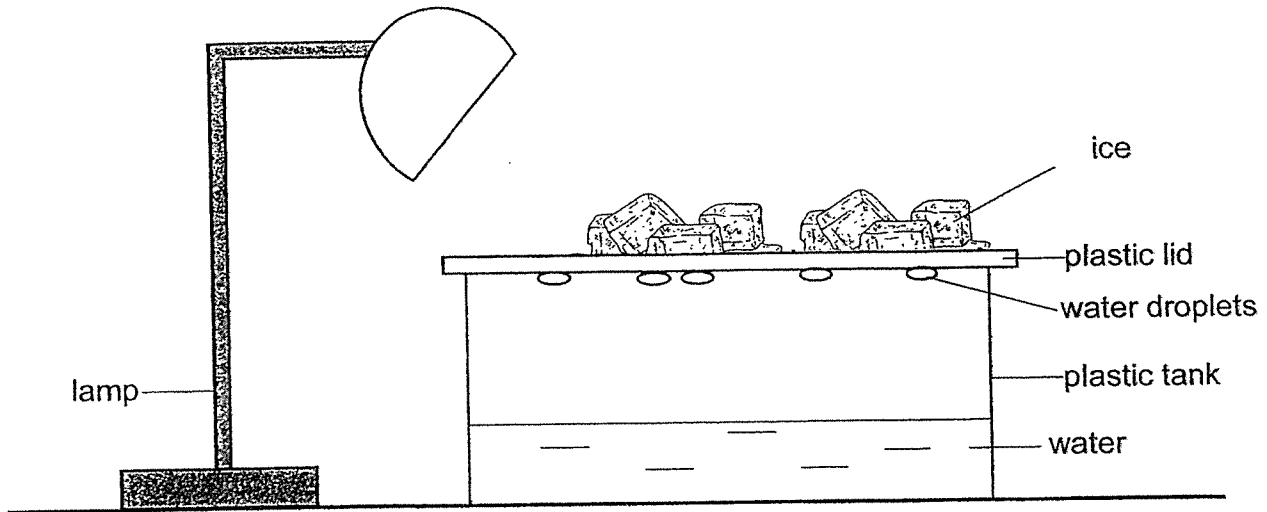

(a) State the two processes that are happening which contribute to the water cycle. [1]

(b) What is the purpose of the lamp in this experiment? [1]

(c) State the importance of water cycle. [1]

- 37 Minah filled two containers each with 100 ml of water and conducted an experiment as shown below.

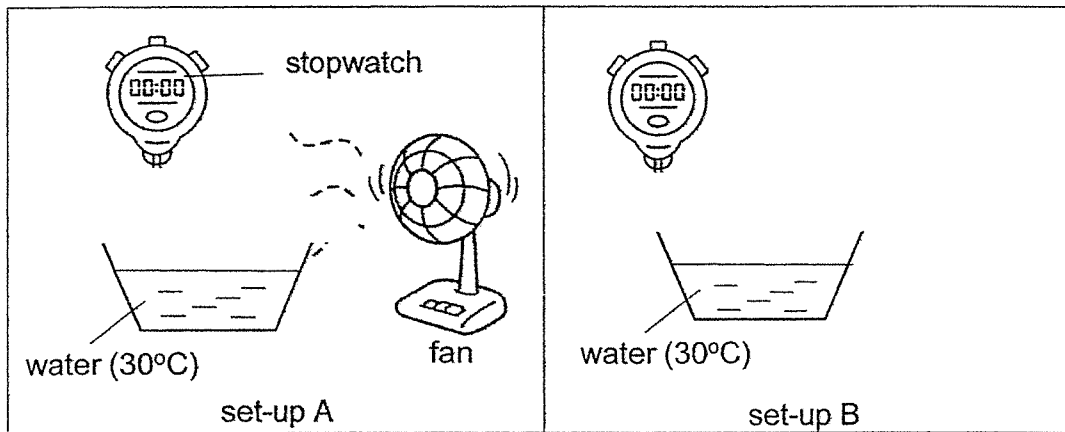

- (a) What is the aim of Minah's experiment? [1]

- (b) In which set-up, A or B, will the water level be lower in the container after an hour? Give a reason for your answer. [1]

- (c) Minah wants to dry her towel in the kitchen as shown below.

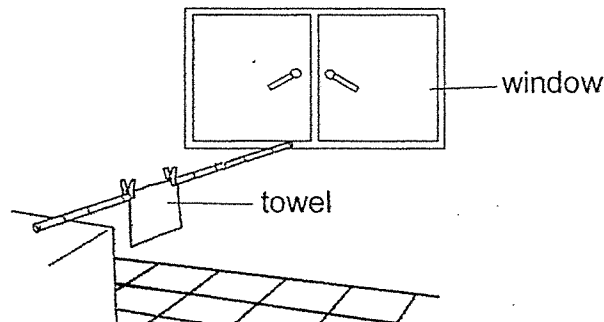

- Using Minah's experiment, what should she do to dry her towel in the kitchen as fast as possible without adding any apparatus? [1]

38 Siti heated some water in a pan as shown below.

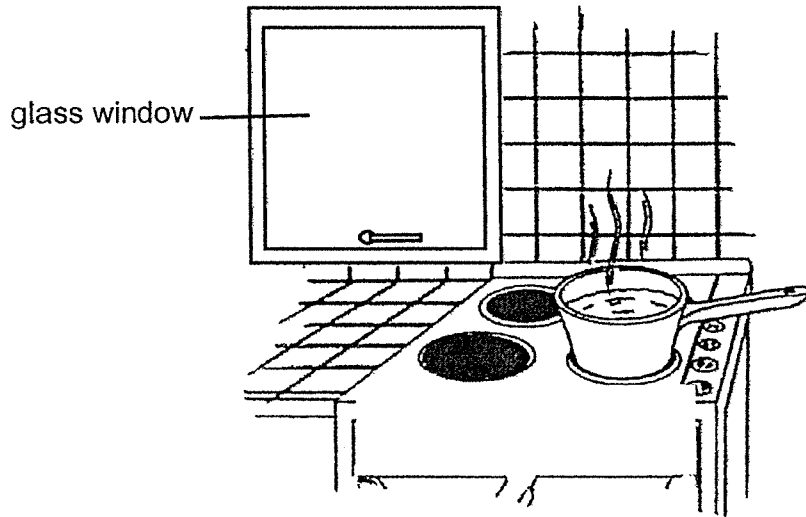

(a) After ten minutes, the water boiled. What is the change in state of water when it boils. [1]

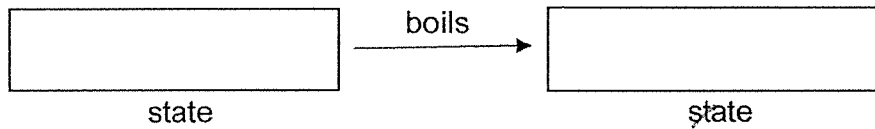

(b) Siti observed water droplets on the glass window after 10 minutes. Explain why. [2]

- 39 Part of the set-up for a game is shown below. A ring is put through the metal structure so that it can move freely from P to Q. The ring is also connected to a electric buzzer under the table. When the ring touches the metal structure, the buzzer sounds.

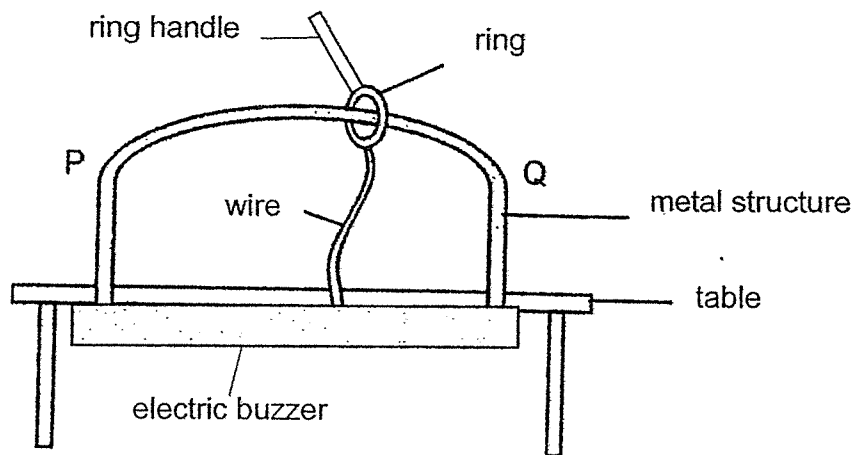

- (a) In the game, a player has to hold the ring handle and move it from P to Q without sounding the buzzer.

Which part of the set-up is not shown in the picture above? Why is that part important? [2]

- (b) Can the ring be made of plastic? Explain your answer [2]

40 Dave wants to make an electromagnet with metal P with coiled wires, three wires, two batteries and one switch.

(a) In the box below, complete the closed circuit diagram with circuit symbols to make an electromagnet. [2]

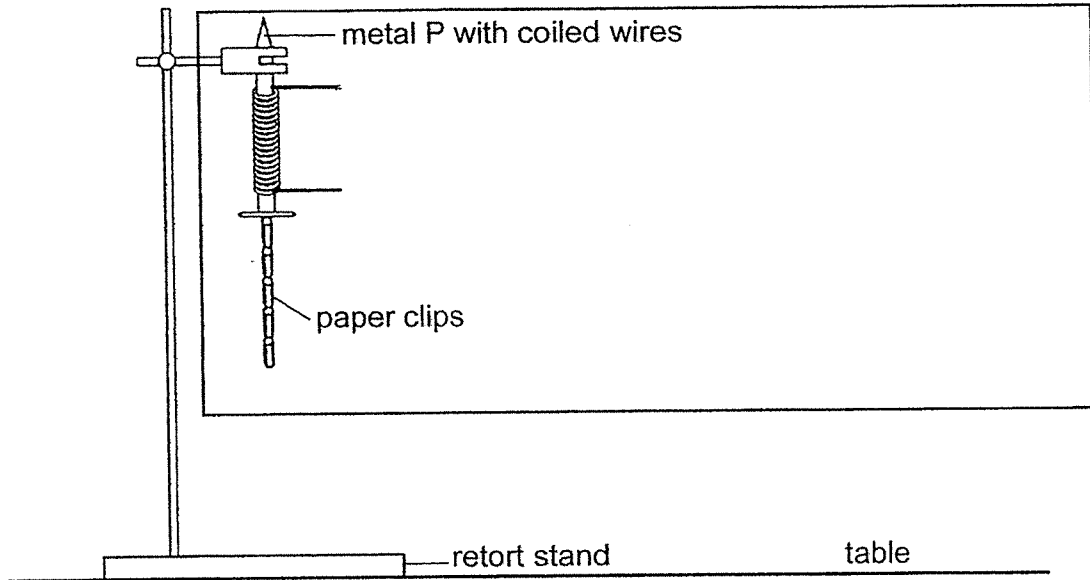

(b) Dave made another electromagnet with metal Q. He used paper clips to test the magnetic strength of each electromagnet. He concluded that both electromagnets have the same magnetic strength.

What would be the evidence to support the above conclusion? [1]

Question 40 continues on page 15

Dave opened the circuit, the paper clips on metal P dropped immediately but not the paper clips on metal Q.

Based on this observation , he wanted to make an electromagnet for a crane in a junkyard to separate and collect magnetic objects as shown below.

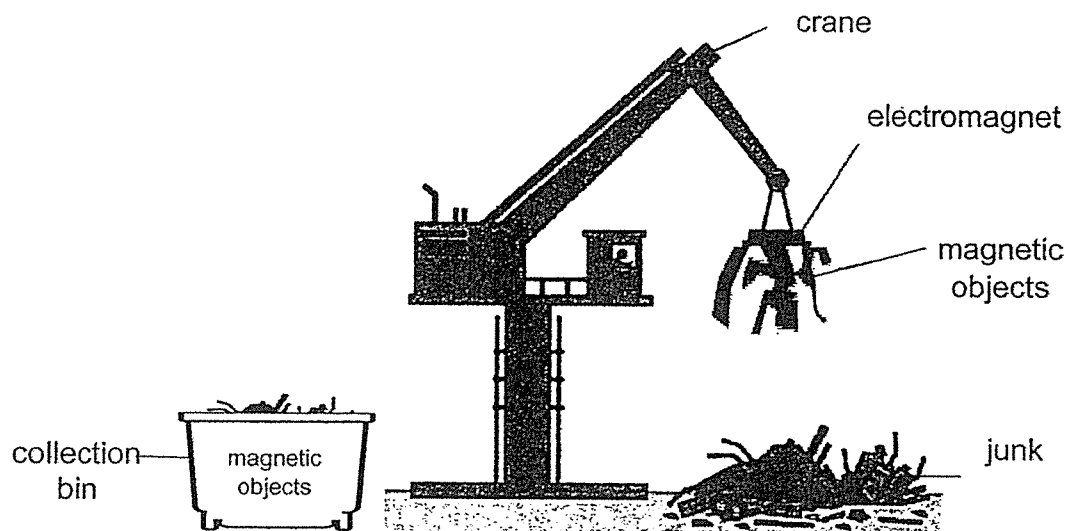

- (c) Which metal, P or Q, should he use for the electromagnet to do the work?
Explain your answer. [2]

End of paper